

Power Analyser UMG 103

Installation and Putting into Service



Janitza electronics GmbH
Vor dem Polstück 1
D-35633 Lahnau
Support tel. 0049 6441 9642-22
Fax 0049 6441 9642-30
E-mail: info@janitza.com
Internet: <http://www.janitza.com>

Janitza®

General Information	4
Copyright	4
Protected trademarks	4
Liability disclaimer	4
Comments on the manual	4
Meaning of the symbols used	5
Inspection on receipt	6
Scope of supply	7
Available accessories	7
Notes on Use	8
Product Description	10
Intended use	10
Features	11
Operating concept	12
GridVis programming software	12
Installation	14
Installed position	14
Power supply voltage	15
Voltage measurement	16
Current measurement	18
Ammeter	19
Direct measurement	19
RS485 interface	22
What to do in case of errors	24
Service and maintenance	26
Repair and calibration	26
Front film	26
Firmware update	26
Service	26
Technical specifications	28
Transport and storage	28
Ambient conditions during operation	28
General information	28
RS485 interface	29
Measurement uncertainty	30
Measurement	32
Voltage measurement	32
Current measurement	32

Appendix	33
Declaration of conformity	33
Dimensioned drawings	34
UMG103 connection example	35
Measuring-circuit and power supply voltage	35
Current measurement	35
Quick Reference Instructions	36
Device address	36
LED display	36

General Information

Copyright

This manual is subject to the statutory copyright protection provisions and may not be photocopied, reprinted, reproduced as a whole or in parts, by mechanical or electronic means, nor copied or further published in any other way whatsoever without the legally binding, written consent of

Janitza electronics GmbH,
Vor dem Polstück 1,
D 35633 Lahnau,
Germany.

Protected trademarks

All trademarks and their resulting rights belong to the respective holders of these rights.

Liability disclaimer

Janitza electronics GmbH does not accept any responsibility whatsoever for errors or deficiencies within this manual and does not undertake any obligation to keep the content of this manual up to date.

Comments on the manual

We welcome your comments. If anything in this manual seems unclear to you, please let us know by sending an eMail to: info@janitza.de

Meaning of the symbols used

The following pictograms are used in this manual:



Dangerous voltage!

Danger or risk of severe injury. Disconnect the system and device from the power supply before starting the work.



Important!

Please note and follow the documentation. This symbol is intended to warn you of possible hazards that can occur during installation, starting up and use.



PE (protective earth) terminal.

Inspection on receipt

Fault free and safe use of this device requires appropriate transport, proper storage, erection and assembly as well as careful operation and maintenance. If it can be assumed that safe operation is no longer possible, the device must be immediately taken out of service and secured against being accidentally started up.

The device must be unpacked and packed with the usual care, without the use of force and only using suitable tools. The devices must be visually inspected for perfect mechanical condition. Please also note and follow the installation instructions enclosed with the device.

It can be assumed that safe operation is no longer possible if the device, e.g.

- has visible damage,
- no longer works, despite intact mains power supply,
- has been exposed to unfavourable conditions (e.g. storage outside the permissible climatic limits without adjustment to the ambient climate, condensation, or similar) for a lengthy period or was exposed to unfavourable effects or loads during transport (e.g. fall from a large height even if there is no visible external damage, or similar).

Please check the scope of supply for completeness before you start installing the device.



The installation and start-up instructions also describe options which do not belong to the scope of supply.



All screw-type terminals belonging to the scope of supply are plugged into the device.



All supplied options and design versions are described on the delivery note.

Scope of supply

Number	Product No.	Name
1	52 18 xxx ¹⁾	UMG103 XX ²⁾
1	33 03 071	Installation and start-up instructions.
1	51 00 116	CD with the following content: - "GridVis" programming software, - Functional description, - Supplementary device descriptions.
1	1001818	Plug-in screw-type terminal, 2-pin.
1	1001819	Plug-in screw-type terminal, 4-pin.
1	1001820	Plug-in screw-type terminal, 6-pin.

1) Refer to delivery note for product number.

2) Design version.

Available accessories

Product No.	Name
18 08 094	RS485, external terminating resistor, 120 Ohm

Notes on Use

Please read these operating instructions and all other publications which have to be used to work with this product (in particular for installation, operation or maintenance).

Note and follow all safety instructions as well as any warnings. If you do not follow the instructions, personal injuries and/or damage to the product could be the result.

Any unauthorised change or use of this device which extends beyond the given mechanical, electrical or other operating limits can cause personal injuries and/or damage to the product.

Any such unauthorised change is “misuse” and/or “negligence” under the product's warranty and therefore excludes the warranty for cover of possible resulting injuries or damage.

This device may be solely operated and maintained by skilled persons.

Skilled persons are people who, on the basis of their relevant training and experience, are capable of identifying risks and avoiding possible hazards which operation or maintenance of the device can cause.

When using the device, any additional legal and safety regulations required for the respective use must be observed.

**Important!**

If the device is not operated according to the instruction manual, protection is no longer ensured and the device can cause hazards.



Conductors with soldered individual wires are not suitable for connection to screw-type terminals.



Only pluggable screw terminals with the same number of poles (pins) and of the same type may be plugged together.



The UMG103 is programmed and read out via RS485 interface only.

Product Description

Intended use

The UMG103 is intended to be used for the measurement and calculation of electrical variables such as voltage, current, power, work, harmonic components, etc. in building installations, at distribution boards, circuit-breakers and busbar trunking systems.

The UMG103 is permanently installed in control cabinets or small distribution boards. It can be installed in any position. The measurement results can be read out via the RS485 interface.

The UMG103 draws its power supply voltage from the measuring-circuit voltage. The UMG103 is designed for operation in low-voltage distribution systems, in which overvoltage category III (300 V) impulse voltages can occur. The UMG103 can measure L-N voltages of up to 240 V and short-term overvoltages up to 300 Vrms.

The current measurement inputs of the UMG103 are connected via external $..1A$ or $..5A$ current transformers.

The UMG103 is only conditionally suitable for measurements in medium and high-voltage distribution systems, as it draws the power supply voltage from the measuring-circuit voltage and therefore loads the voltage transformer with a non-linear current. Special safety provisions are to be applied to the measurements in medium and high-voltage distribution systems, which are not dealt with here.

The UMG103 fulfils the test requirements for use in industrial areas.

The UMG103 bridges power failures of max 80 ms with a mains voltage of 230 V AC.

The UMG103 saves all min-, max-, energy values as well as runtime counters in a non-volatile memory approximately every 5 minutes.

The refresh time of the measured values depends on the set net frequency (at 50Hz: 200ms; at 60Hz: 167ms).

Features

- Measurement in TN and TT systems,
- 3 voltage measurement inputs (300V CATIII),
- 3 current measurement inputs,
- RS485 (Modbus RTU),
- Installation on top-hat rails, 4,TE
- Suitable for installation in distribution boards.
- Continuous scanning of the voltage and current measurement inputs,
- Energy measurement, measurement uncertainty class 0.5 for ..5A current transformers,
- Energy measurement, measurement uncertainty class 1 for ../1A current transformers,
- Fourier analysis 1st to 25th harmonic component (all uneven harmonics) for U and I,
- THD U, THD I,
- Measurement of the distortion reactive power,
- Measurement of positive, negative and zero phase-sequence system,
- Storage of the minimum, maximum and energy values,
- Scanning frequency 5.4 kHz.

Operating concept

The UMG103 is programmed and read out via the RS485 interface only. The device address is directly set via 2 coding switches.

GridVis programming software

The UMG103 can be programmed and read out using the GridVis programming software included in the scope of supply. To this end the UMG103 must be connected to a PC via the RS485 interface.

GridVis features

- Programming the UMG103
- Storing data in a database
- Graphic display of measured values.

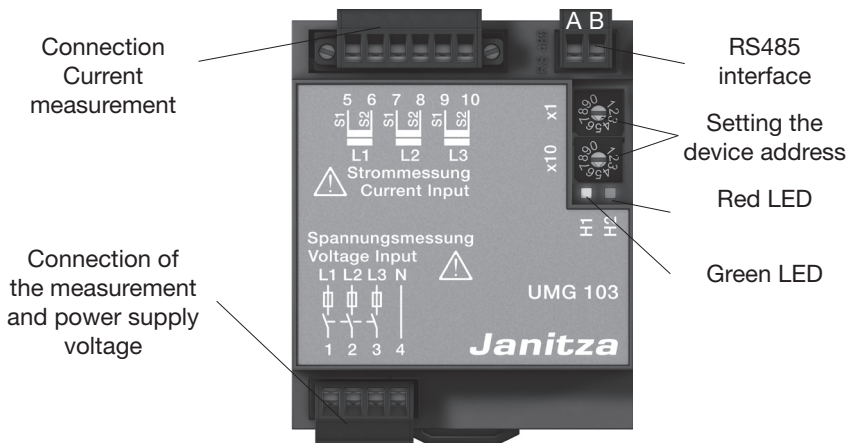

Fig.: View of the UMG103.

Block diagram of measurement and power supply voltage

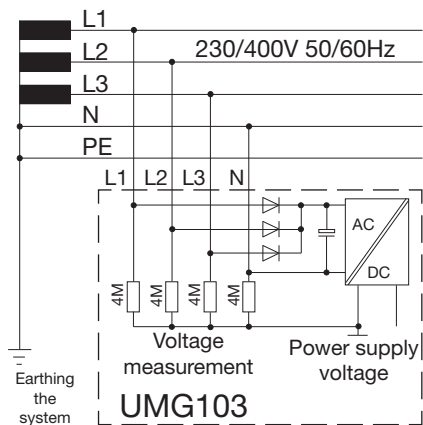

Fig. block diagram, UMG103 in TN system.

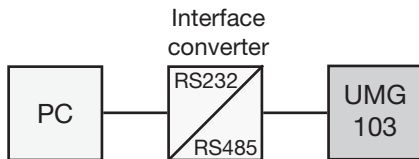

Fig. Connection of a UMG103 to a PC via an interface converter.

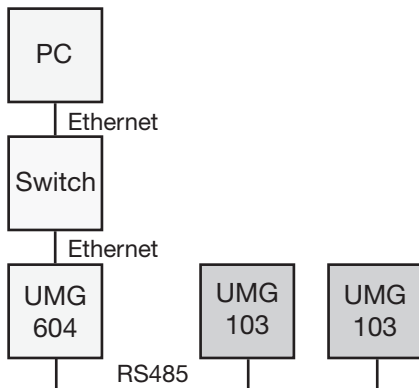

Fig. Connection of several UMG103 to a PC via a UMG604 (with the ethernet option).

Installation

Installed position

The UMG103 can be installed in control cabinets or in small distribution boards according to DIN 43880. It is mounted on a 35 mm mounting rail according to DIN EN 60715. It can be installed in any position..

Mounting rail

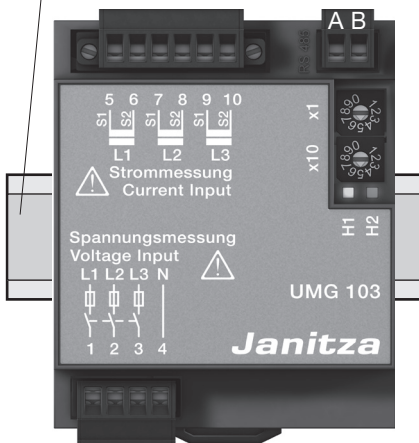

Fig. UMG103 on mounting rail according to DIN EN 60715.

Power supply voltage

The power supply voltage required for operation of the UMG103 is drawn from the L1-N, L2-N and L3-N measuring-circuit voltages. At least one phase must lie within the rated voltage range.

The UMG103 requires a voltage of at least 100 Veff in at least one phase (L-N) to operate.

The connection leads for the measuring-circuit and power supply voltage must be routed via a disconnecter and protected with a fuse.



Voltages which are above the allowable voltage range can destroy the device.



Before applying the measuring-circuit and power supply voltage, ensure that the voltage and frequency matches the information given on the rating plate!



Important!

- A disconnecter or circuit-breaker must be provided for the measuring-circuit and power supply voltage in the building installation.
- The disconnecter must be installed near the device and must be easy for the user to reach.
- The switch must be labelled as a disconnecting device for this device.

Voltage measurement

The UMG103 is designed for operation in low-voltage distribution systems, in which overvoltage category III (300 V) impulse voltages can occur.

The UMG103 can measure L-N voltages of up to 240 V and short-term overvoltages up to 300 Vrms.

The UMG103 can be used in three-phase 4 conductor system (TN, TT system) (50 Hz, 60 Hz) with earthed PEN conductor.

The UMG103 draws the power supply voltage required for operation from the measuring-circuit voltage.

The instrument leads required for the voltage measurement must be suitable for voltages up to 300 VAC to earth and 520 VAC conductor to conductor.

Instrument leads must be fused by an overcurrent protective device and routed via disconnectors.

The UMG103 is only conditionally suitable for measurements in medium and high-voltage distribution systems, as it draws the power supply voltage from the measuring-circuit voltage and therefore loads the voltage transformer with a non-linear current.

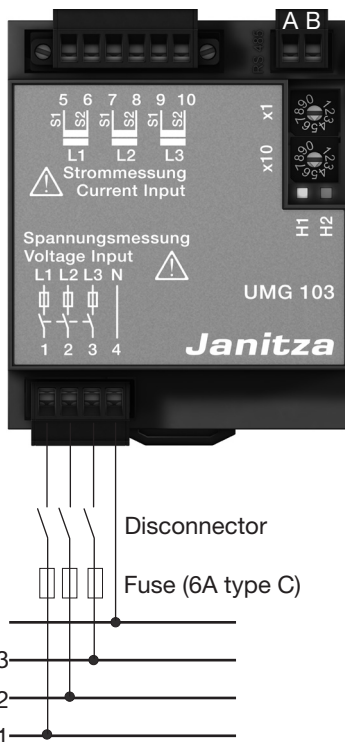

Fig. 16.1 Connection example: Voltage measurement via disconnectors and fuses.



Important!
The voltage measurement inputs are hazardous live!

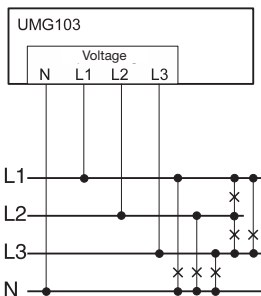

Fig. 17.1 Connection example for direct voltage measurement.

U_{L-N} / U_{L-L}
120V / 208V
127V / 220V
220V / 380V
230V / 400V
240V / 415V

Max. rated voltage

Fig. 17.3 Table of the suitable rated voltages.

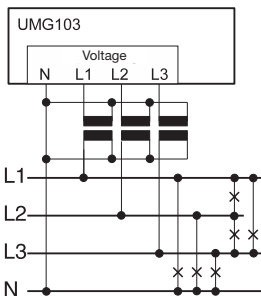

Fig. 17.2 Connection example for voltage measurement via voltage transformer.



Important!
 Voltages above 240 VAC to earth must be connected via voltage transformers.



Important!
 The UMG103 is not suitable for the measurement of direct voltages.

Current measurement

The UMG103 is designed for the connection of current transformers with secondary currents of $..1A$ and $..5A$. Only alternating currents, not direct currents, can be measured.

Each current measurement input can be permanently loaded with 6A or for 1 second with 100 A.

Current transformers, which are not loaded on the secondary side can conduct dangerous contact voltages and therefore must be short-circuited.

The current transformer ratio can be programmed via RS485 using the software GridVis only.

The current transformer ratio is set to 5/5A in our factory and must be adapted to the used current transformers.

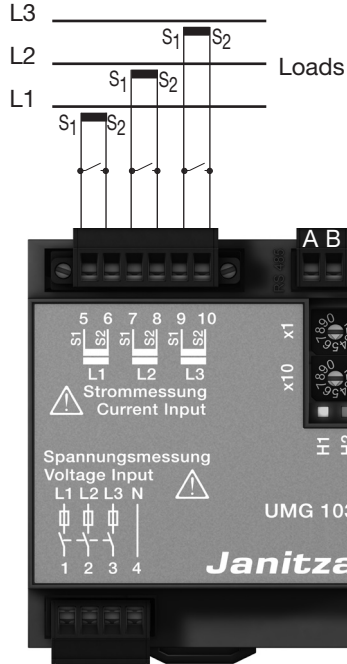

Fig.18.1 Connection example, current measurement via current transformer.



Important!
The UMG103 is not suitable for the measurement of direct voltages.



Important!
The current measurement inputs are hazardous live!



Earthing current transformers.
If a connection is provided for earthing the secondary winding, this must be connected with earth.

Ammeter

If you not only want to measure the current with the UMG103 but with an ammeter also, the ammeter must be connected in series to the UMG103.

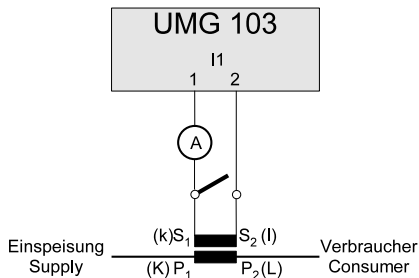

Fig. 19.1 Example, current measurement via additional ammeter.

Direct measurement

Nominal currents up to 5 A can also be measured directly with the UMG103. In this case it must be noted that each current measurement input may be loaded continuously with 6 A or for 1 second with max 100 A.

As the UMG103 does not have any integrated protection for the current measurement, this protection (e.g. 6A fuse type C) must be provided for during installation.

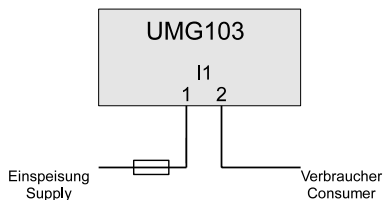

Fig. 19.2 Example, direct current measurement.

Summation current measurement

If the current is measured via two current transformers, the total transformation ratio of the current transformers must be programmed in the UMG103.

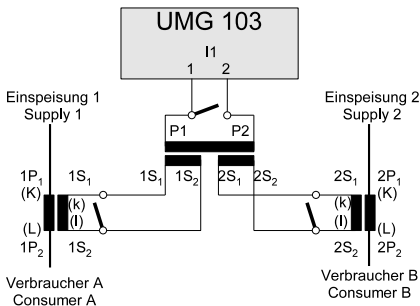

Fig.20.1 Example, current measurement via summation current transformers.

Example

The current is measured via two current transformers. Both current transformers have a transformation ratio of 1000/5A. The summation measurement is performed with a 5+5/5A summation current transformer.

Primary current: $1000A + 1000A = 2000A$

Secondary current: 5A

The UMG103 must then be set as follows:

Address 000 = 2000 (primary current)

Address 001 = 0005 (secondary current)

**Open current transformer!**

High hazardous live voltage peaks can occur at current transformers which are operated open on the secondary side!

The winding insulation in "safe open current transformers" is dimensioned so that the current transformers can be operated open. But these current transformers are also hazardous live if they are operated open.

**Short-circuit current transformer connections!**

The secondary connections of the current transformers must be short-circuited at these first before the current supply leads to the UMG103 are disconnected!

If a testing switch is available, which automatically short circuits the current transformer's secondary leads, it is sufficient to place this in the "test" position, provided the short-circuiters have been tested first.

RS485 interface

The UMG103 has an RS485 interface and operates with the modbus RTU protocol.

The device address 1 and baudrate “automatic detection” is set in the presettings.

Modbus address list

The measured values available in the UMG103 are given in the modbus address list.

The data in the modbus address list can be called up in

- Big-endian (high byte before low byte) format and in
- Little-endian (low byte before high byte) format.

The addresses described in this address list return the data in “big-endian” format. If you require the data in “little-endian” format you must add the value 16384 to the address.

Bus structure

All devices are connected in a bus structure (line). Up to 32 stations can be connected together in a segment. The cable at the start and end of a segment is terminated by resistors.

If there are more than 32 stations, repeaters must be used to connect the individual segments.

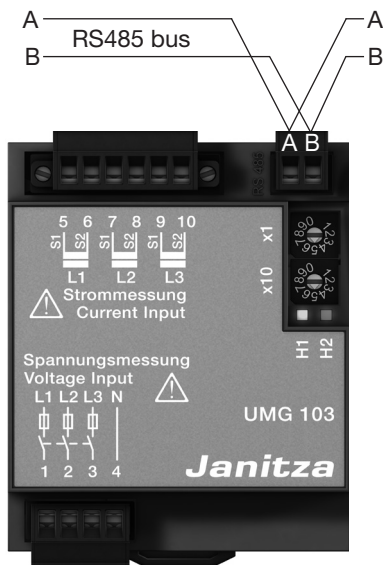

Terminating resistors

The cable at the start and end of a segment is terminated by with resistors (120 ohm, 1/4 W).

The UMG103 does not contain any terminating resistors.

Correct

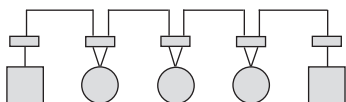

Incorrect

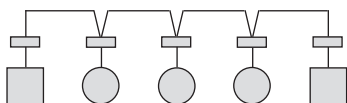

 Terminal strip in the control cabinet.

 Device with RS485 interface.
(Without terminating resistor)

 Device with RS485 interface.
(With terminating resistor at the device)

Shielding

A twisted-conductor and shielded cable must be provided for connections via the RS485 interface. The shielding at both ends of the cable must be connected to a large area of the housing or cabinet parts in order to achieve an adequate shielding effect.

Cable type

Recommended cable types:

Unitronic Li2YCY(TP) 2x2x0.22 (Lapp cables)

Unitronic BUS L2/FIP 1x2x0.64 (Lapp cables)

Cable length

1200 m for a baud rate of 38.4 k



For the wiring of the Modbus connection, CAT cables are not suitable. Please use the recommended cables.

What to do in case of errors

Possible error	Cause	Remedy
No LED is lit.	External fusing for the power supply voltage has tripped. Device is defective.	Replace fuse. Send device to the manufacturer for repair.
Measured current is too large or too small.	Current transformer factor is incorrectly programmed.	Read out current transformer ratio and program with the software GridVis.
Measured current is too small.	Overrange. The peak current value at the measurement input has been exceeded by harmonic components.	Install larger current transformer. Install larger current transformer. Important! Ensure the measurement inputs are not overloaded.
Measured voltage is too small or too large.	Measurement in the wrong phase. Voltage transformer incorrectly programmed.	Check connection and correct if necessary. Read out voltage transformer ratio and program with the software GridVis.
Measured voltage is too small.	Overrange The peak voltage value at the measurement input has been exceeded by harmonic components.	Install voltage transformers. Install voltage transformers. Important! Ensure the measurement inputs are not overloaded.

Possible error	Cause	Remedy
Active power too small or too large.	The programmed current transformer transformation ratio is incorrect.	Read out current transformer ratio and program with the software GridVis.
	The current path is assigned to the wrong voltage path. The programmed voltage transformer transformation ratio is incorrect.	Check connection and correct if necessary. Read out voltage transformer ratio and program with the software GridVis.
Active power imported supply / supply is reversed.	At least one current transformer connection is mixed up/reversed.	Check connection using the software GridVis and correct, if necessary.
	A current path is assigned to the wrong voltage path.	Check connection using the software GridVis and correct, if necessary.
No connection with the device.	RS485: - Device address is incorrect. - Wrong protocol.	Adjust the device address. Select protocol.
Despite the measures above the device does not work.	Device is defective.	Send device to the manufacturer for checking with a precise description of the error.

Service and maintenance

The device is subjected to various safety checks before delivery and marked with a seal. If a device is opened, the safety checks must be repeated. A warranty will be provided for unopened devices only.

Repair and calibration

Maintenance and calibration work can only be carried out in the manufacturer's factory.

Front film

The front film can be cleaned with a soft cloth and standard household cleaning agent. Do not use acids and products containing acid for cleaning.

Disposal

The UMG103 can be reused or recycled as electronic scrap in accordance with the legal provisions.

Firmware update

If a firmware update has to be performed for your UMG103 you can do this with the GridVis software included in the scope of supply.

Service

Should questions arise, which are not described in this manual, please contact us directly.

We will need the following information from you to answer any questions:

- Device name (see rating plate),
- Serial name (see rating plate),
- Software release (see measured value display),
- Measuring-circuit voltage and power supply voltage,
- Precise description of the error.

Technical specifications

Transport and storage

The following information applies to devices which are transported or stored in the original packaging.

Free fall	: 1m
Temperature	: -20°C to +70°C

Ambient conditions during operation

The UMG103 is intended for weather-protected, stationary use. The UMG103 fulfils the use conditions according to DIN IEC 60721-3-3.

Class II according to IEC 60536 (VDE 0106, Part 1), i.e. a PE terminal is not required!

General information

Net weight	: 150g
Device dimensions	: approx. l=71.5 mm, b=98 mm, h=46mm
Housing flammability class	: UL94V-0
Installed position	: any
Fixing/mounting	: 35 mm top hat rail (according to IEC/EN 60999-1, DIN EN 50022)
Operating temperature range	: -10°C. +55°C
Relative humidity	: 5 to 95 %, (at +25 °C) without condensation
Degree of pollution	: 2
Operating altitude	: 0 .. 2000 m above sea level
Installed position	: any
Ventilation	: Forced ventilation is not required.
Protection against ingress of solid foreign bodies and water	: IP20 according to EN 60529 September 2000 IEC 60529:1989
Connectable conductors	
Solid core, multi-core, flexible core	: 0.08 - 2.5 mm ² , AWG 28 - 12
locking torque	: 0.5 Nm max
strip length min.	: 8 mm

RS485 interface

Protocol, modbus RTU

Transfer rate

: Modbus RTU/slave,

: 9.6 kbps, 19.2 kbps, 38.4 kbps,

57.6 kbps, 115.2 kbps,

automatic detection

Measurement uncertainty

The measurement uncertainty of the UMG103 applies to use of the following measuring ranges. The measured value must lie within the given limits. Outside these limits the measurement uncertainty is unspecified.

The specifications apply under the following conditions:

- Annual recalibration,
- a warming up time of 10 minutes,
- an ambient temperature of 18 .. 28°C.

If the device is operated outside the range from 18 .. 28°C an additional measurement error equal to $\pm 0.01\%$ of the measured value must be taken into account per °C difference.

Measured value	Measurement uncertainty IEC 61557-12, DIN EN 61557-12
Voltage L-N	0,2
Voltage L-L	0,2
Current L	0,5
Current N	1,0
Real power	0,5
Apparent power	0,5
Reactive power	0,5
CosPhi	0,2
Leistungsfaktor	2,0
Frequency	0,1
Real energy	0,5
Reactive energy	2,0
Apparent energy	0,5
THD voltage	3,0
THD current	3,0

Real energy	
Current transformer ../5A	Class 0,5S (DIN EN62053-22:2003) Class B (DIN EN50470-3:2006)
Current transformer ../1A	Class 1 (DIN EN62053-21:2003) Class A (DIN EN50470-3:2006)
Reactive energy	
Current transformer ../5A	Class 2 (DIN EN62053-23:2003)
Current transformer ../1A	Class 2 (DIN EN62053-23:2003)

Measurement

Voltage measurement

Important! The power supply voltage is acquired from the measuring-circuit voltage.

Power supply voltage range	
for supply from single phase	: 115 .. 240V (+- 10%), 45-65Hz
for supply from three phases	: 80 .. 240V (+- 10%), 45-65Hz
Dreiphasen- 4-Leitersysteme (L-N/L-L):	max. 240V/415V
Power input	: max. 4VA
Overvoltage category	: 300V CATIII
Resolution	: 0,01V
Crest-Faktor	: 2 (relating to 240Vrms)
Scanning frequency	: 5,4kHz
Frequency of the fundamental	: 45Hz .. 65Hz
Auflösung	: 0,001Hz

Current measurement

Nominal current	: 5A
Rated current	: 6A
Overload for 1 sec	: 60A (sinusoidal)
Resolution	: 0,1mA
Crest-Faktor	: 2 (relating to 6Arms)
Overvoltage category	: 300V CATIII
Power input	: approx 0,2 VA (Ri=5mOhm)
Scanning frequency	: 5,4kHz

Appendix

Declaration of conformity

The UMG103 fulfils the safety requirements of:
Directive 2004/108/EC in conjunction with DIN EN 61326-1 (2006-10) and
Directive 2006/95/EC in conjunction with EN 61010-1 (2002-08)

Safety requirements

Safety requirements for electrical instrumentation, control and laboratory equipment

: EN 61010-1 08:2002, IEC 61010-1:2001

Protection class

: II (device without protective conductor)

EMC requirements

Emitted interference, residential area

: DIN EN 61326-1:2006, Class A, IEC 61326-2-1:2005

Interference immunity, industrial area

: DIN EN 61326-1:2006, Table 2, IEC 61326-2-1:2005

Housing

: Electrostatic discharge, IEC 61000-4-2 (4 kV/8 kV)

: Electromagnetic fields, IEC 61000-4-3:2002 (10 V/m)

: Electromagnetic fields, IEC 61000-4-8:2000 (100A/m)

Measuring-circuit and power supply voltage

: Voltage dips, IEC 61000-4-11 (0.5 periods)

: Bursts, IEC 61000-4-4 (2 kV)

: Surge voltages, IEC 61000-4-5 (2 kV)

: Conducted HF signals, IEC 61000-4-6 (3 V)

RS485 : Conducted HF signals, IEC 61000-4-6 (3 V)

: Bursts, IEC 61000-4-4 (1 kV)

: Surge voltages, IEC 61000-4-5 (2 kV)

Dimensioned drawings

Front view

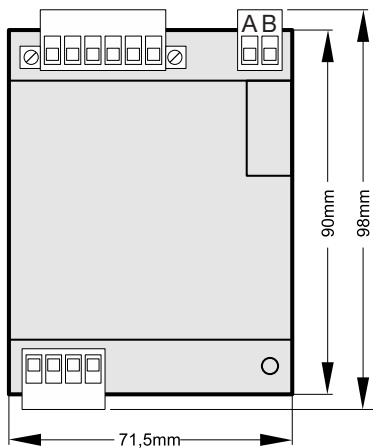

Side view

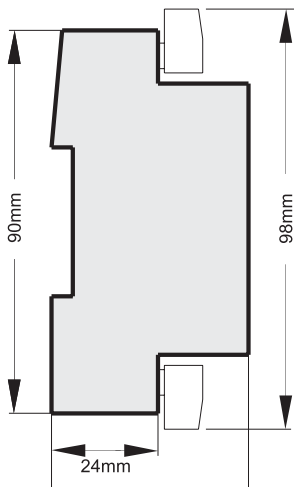

UMG103 connection example

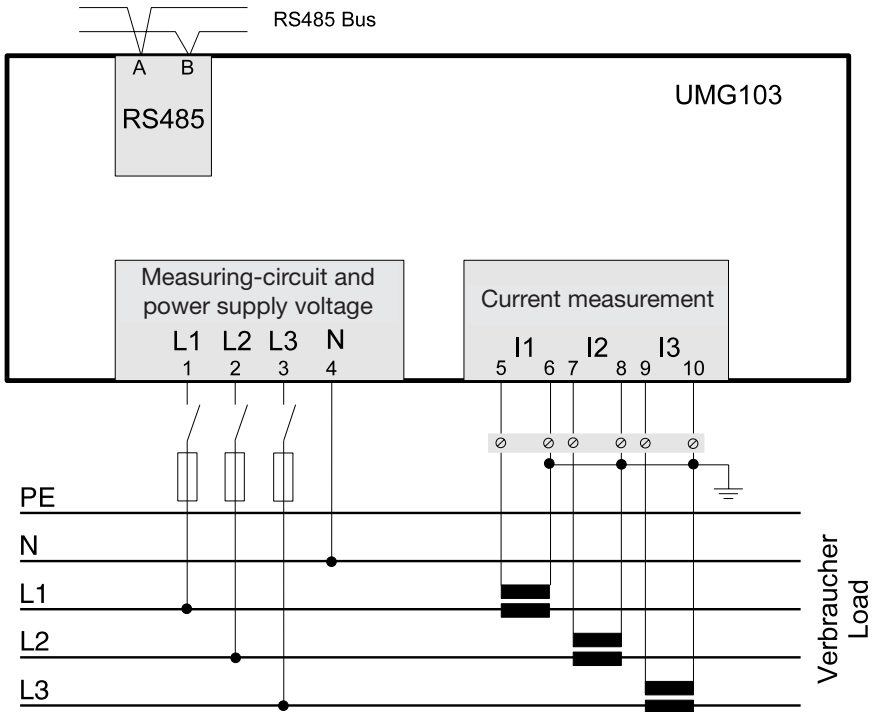

Quick Reference Instructions

Device address

x10 x1



0 0 For service purposes only!

If the device is switched on with address 00 the bootstrap loader is active. The device is not ready for use.

The LEDs flash alternately.



The current boot loader can now be overwritten.

9 9 Device addresses within the range from 1 to 99 only can be set for the UMG103.

LED display

H1 H2
green red

 All measuring-circuit and power supply voltages lie within the operating voltage range. The device is working. The LED goes out for 0.5 sec every 5 sec.

  The device is ready for use but at least one measuring-circuit and power supply voltage is smaller than the operating voltage range.

 Data transfer on the RS485 is active.

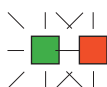
 The LEDs flash simultaneously. Data transfer on the RS485 is active but faulty.

 A fatal error exists in the device. The device must be checked by the manufacturer.

 An overrange exists (i.e. measuring range is exceeded) at at least one current or voltage measuring input.

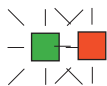
 The LEDs flash alternately. A firmware checksum error exists. The device is not ready for use. Perform a firmware update.